

EM640



Energy meter for three phase, two phase and single phase systems



Benefits

- **Quick configuration.** The configuration wizard which runs when the system is started up for the first time allows you to commission the unit without errors in a matter of seconds. The UCS configuration software is available for download free of charge.
- **User-friendly interface.** The 128x96 matrix LCD with backlit display ensures perfect visibility and readability of the information. Page configuration and browsing are very intuitive, thanks to the user interface with 3 mechanical keys. Finally, the page filter allows you to hide the unnecessary information.
- **Flexible installation.** It can be installed in Single-phase, two-phase and three-phase (with or without neutral). It also permits the monitoring of 3 loads in single-phase systems.
- **Robust design.** Able to work in an extremely wide temperature range, up to 70 °C / 158 °F., thanks to the temperature drift compensation and up to 3000 m / 9842.5 ft altitude.
- **Multi-interface communication.** EM640 is able to transmit and receive data through Modbus TCP/IP or HTTPS rest API via Ethernet.

Description

EM640 is a direct connection energy analyser, for single- and three-phase systems up to 480 V L-L and current up to 65 A.

Modbus TCP/IP and HTTPS rest API communication is available via Ethernet port.

Applications

EM640 can be installed in any low-voltage switchboard with rated current up to 65 A, to monitor the energy consumption, the main electrical variables and the harmonic distortion.

If used to monitor a single machine, it provides all the main electrical variables to identify any possible malfunction in its early stage and can correlate the energy consumption with the hours of operation, to plan maintenance and prevent failures. The partial meter reset function, allows you to monitor each individual machine cycle.

Thanks to the measurement refresh time (100 ms) and to the high resolution of the variables available through Modbus communication modules, it can also be used as data source for control actions, such as avoiding feeding energy into the electricity grid in a photovoltaic installation with energy storage.

EM640 B is the perfect solution when Ethernet connection is needed in combination with inverter and energy storage systems or installed in machines and industrial environments to monitor single loads or total consumption.

Main functions

- Active, reactive and apparent energy measurement
- Main electrical variables measurement
- Load run hours and total ON time
- Total harmonic distortion (THD) of current and voltages measurement
- Measured variables visualisation on the display

Main features

- System and phase variables (V L-L, V L-N, A, W/var, VA, PF, Hz)
- Displaying of the active energy with a resolution of 0.001 kWh
- 0.001 Hz frequency resolution
- Average value calculation (dmd) for current and power (kW / kVA)
- Streamlined user interface featuring 3 mechanical buttons
- Modbus TCP/IP (100 ms refresh time) and HTTPS rest API
- Dual ethernet port (internal switch) for easy daisy chain connection without an external switch (E2 versions)
- Continuous sampling of each voltage and current
- Backlit display
- cULus approved (UL 61010)
- SunSpec compliance
- Operating temperature up to 70 °C / 158 °F temperature
- Operating altitude up to 3000 m / 9842.5 ft

UCS software

- Free download from Carlo Gavazzi website
- Configuration through RS485 from PC or trough UWP3.0 via LAN or the web (UWP Secure Bridge function)
- Setups can be saved offline for serial programming with a single command

- Real time data view for testing and diagnostics
- Notification of possible wiring errors and display of the corrective steps, reassignment of the correct association of the phases or the direction of the currents via software control

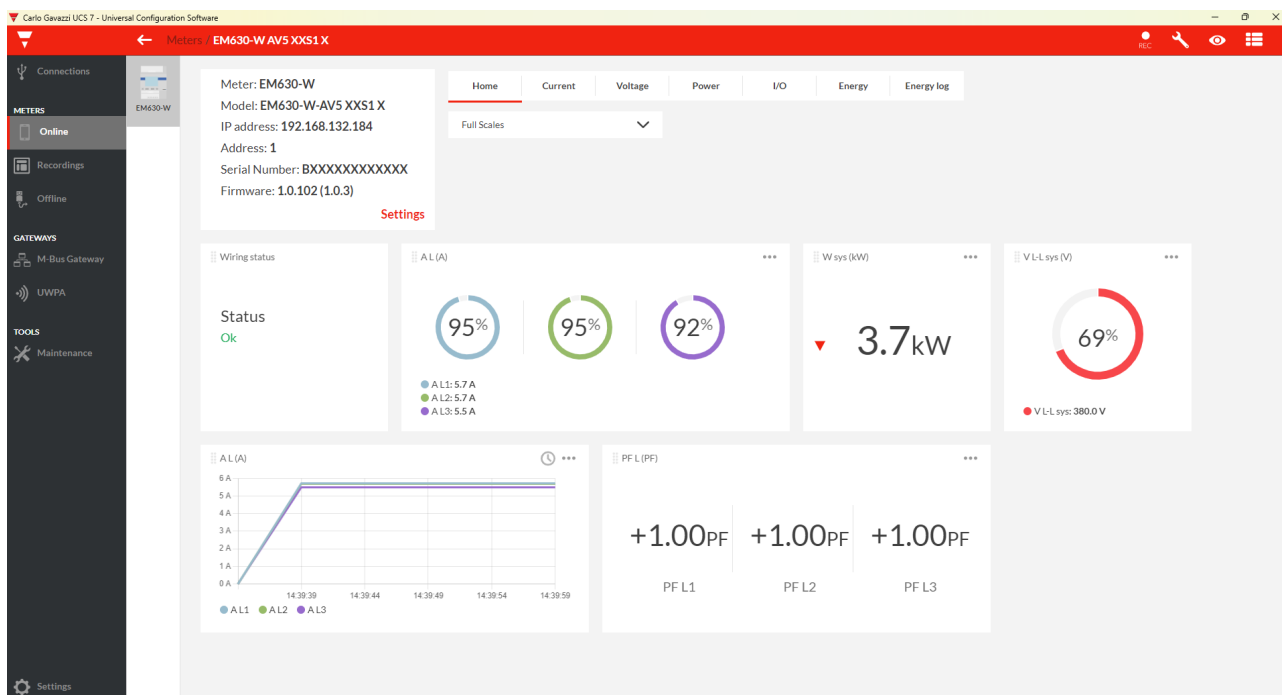

UCS mobile APP

- Free download from Google Play Store
- Configuration through Wi-Fi from Android® mobile phone or tablet
- Setups can be saved offline for recurrent programming with a single command
- Real time data view for testing and diagnostics

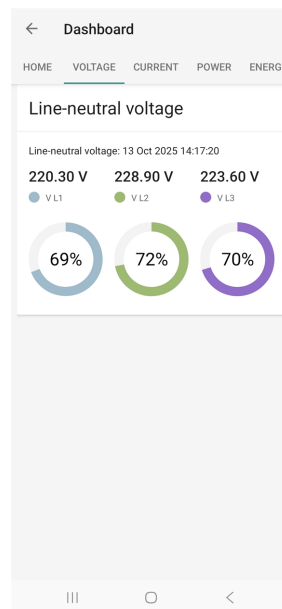
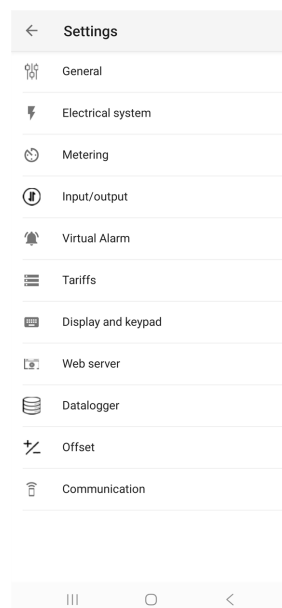
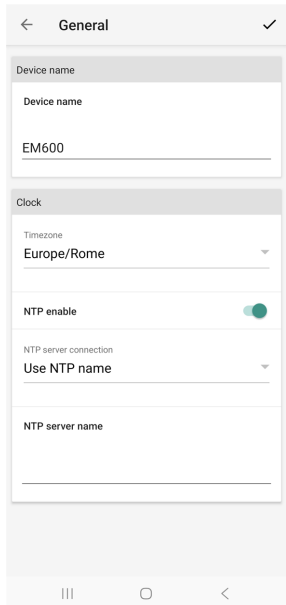
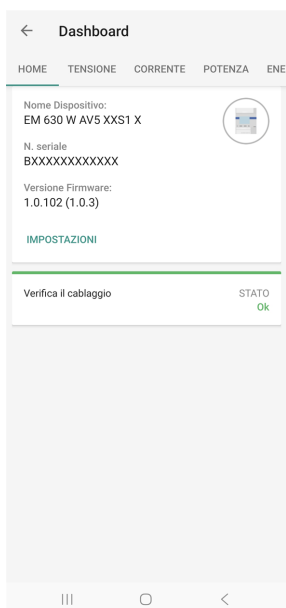

Structure

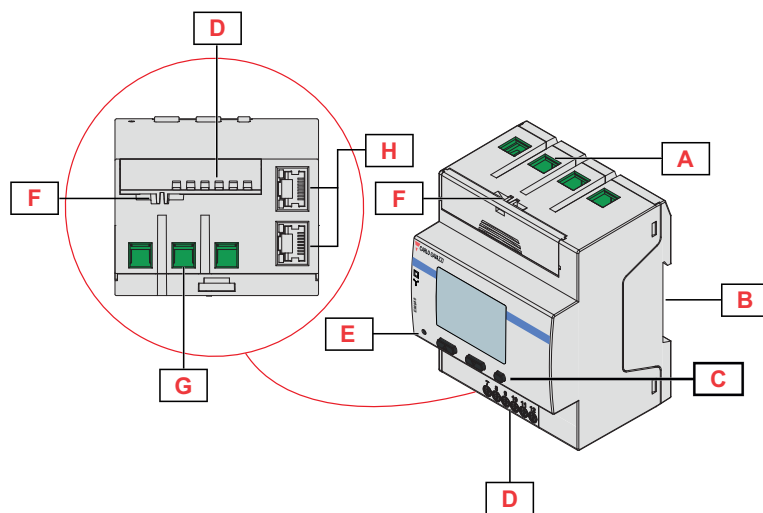

Fig. 1 EM640 front

Area	Description
A	Voltage/Current inputs
B	DIN rail mounting bracket
C	Browsing and configuration buttons
D	Sliding terminal cover
E	LED
F	Voltage/Current Outputs
G	Ethernet RJ45 ports (if present)

Features

General

Material	Housing: PBT Transparent cover: polycarbonate
Protection degree	Front: IP51 Terminals: IP20
Protective class	Class II
Terminals	Measurement inputs (Phase 1, 2, 3, N): 2.5 mm ² to 16 mm ² / 5 to 13 AWG, 2.5 Nm / 22.12 lbin max.
Overvoltage category	Cat. III
Rated impulse voltage	4kV
Pollution degree	2
Utilization category	UC2
Mounting	DIN rail
Weight	370 g / 0.82 lb (packaging included)
Dimensions	4 DIN modules

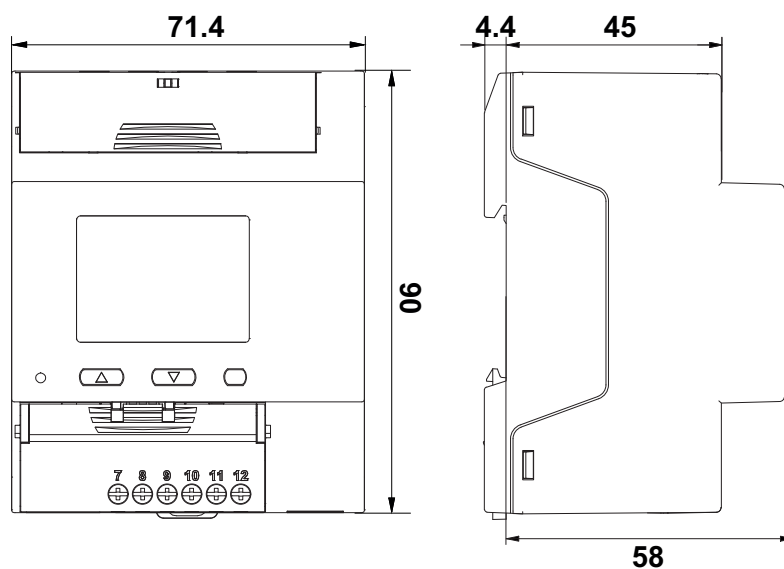

Fig. 2

Environmental specifications

Operating temperature	From -25 to +70 °C (-13 to +158 °F) at I _{max} = 45 A From -25 to +55 °C (-13 to +131 °F) at I _{max} = 65 A
Storage temperature	From -30 to +70 °C / from -22 to +158 °F
Max Altitude	3000 m / 9842.5 ft
Electromechanical environmental condition	E2
Mechanical environmental condition	M2



Note: R.H. < 90 % non-condensing @ 40 °C / 104 °F.

Input and output insulation

Type	Measurement inputs	Ethernet Modbus TCP
Measurement inputs	-	Double/Reinforced
Ethernet Modbus TCP	Double/Reinforced	-

According to: EN IEC 61010-1, EN IEC 62052-31 (MID). Overvoltage category III. Pollution degree 2.

Compatibility and conformity

Directives	2014/53/EU 2014/35/EU (LVD - Low Voltage) 2014/30/EU (EMC - Electro Magnetic Compatibility) 2011/65/EU, 2015/863/EU (Electric-electronic equipment hazardous substances)
Standards	Electromagnetic compatibility (EMC) - emissions and immunity: EN 301 489-1 V2.2.3, EN 301 489-17 V3.2.4, EN 62052-11.2021, EN IEC 61000-6-3, EN IEC 61000-6-2 Safety: EN IEC 61010-1, EN IEC 62052-31 Metrology: EN IEC 62053-21, EN IEC 62053-23, ANSI C12.1
Approvals	 

Note: the equipment must be installed and operated with minimum distance of 20 cm of the human body.

Electrical specifications

Electrical system	
Managed electrical system	Single-phase Three single-phase Two-phase (3-wire) Three-phase with neutral (4-wire) Three-phase without neutral (3-wire) Wild leg system (three-phase, four-wire delta)
MID managed electrical system	Three-phase with neutral (4-wire) Three-phase without neutral (3-wire) Single phase system

Voltage inputs	
Voltage connection	Direct
Rated voltage L-N (U_n minimum to U_n maximum)	120 to 277 V
Rated voltage L-L (U_n minimum to U_n maximum)	208 to 480 V
Voltage tolerance	From 0.8 to 1.15 U_n
Overload	Continuous: 1.15 U_n max.
Input impedance	Refer to "Power supply"
Frequency	50/60 Hz

Note: EM640 can also be installed in a wild leg system (three phases, four delta wires), where one of the phase-neutral voltages is higher than the other two.

Current inputs	
Current connection	Direct
Rated current (I_n)	5 A
Minimum current (I_{min})	0.25 A (0.05 I_n)
Maximum current (I_{max})	65 A (13 I_n)
Start-up current (I_{st})	20 mA (0.004 I_n)
Overload	For 10 ms: 1950 A (30 I_{max})
Input impedance	< 3.4 VA
Crest factor	3 (I_{max} peak 98A)

▶ Power supply

Type	Self power supply
Consumption	4W / 6 VA
Frequency	50/60 Hz

▶ Measurements

Method	TRMS measurements of distorted waveforms
---------------	--

Energy metering

Energy metering depends on the measurement type you chose.

A measurement (Easy connection)

Irrespective of the current direction, the power always has a plus sign and contributes to increase the positive energy meter. The negative energy meter is not available.

B measurement (Bidirectional)

For each measuring time interval, the individual phase energies with a plus sign are summed to increase the positive energy meter (kWh+), while the others increase the negative one (kWh-).

Example:

P L1= +2 kW, P L2= +2 kW, P L3= -3 kW

Integration time = 1 hour

kWh+ = (2+2) x 1h = 4 kWh

kWh- = 3 x 1h = 3kWh

C measurement (Net Bidirectional)

For every measuring interval time, the energies of the single phases are summed; according to the sign of the result, the positive (kWh+) or negative totalizer (kWh-) is increased.

Example:

P L1= +2 kW, P L2= +2 kW, P L3= -3 kW

Integration time = 1 hour

kWh+ = (+2+2-3)x1h = (+1)x1h = 1 kWh

kWh- = 0 kWh

Available measurements

Active energy	Unit	System	Phase
Imported (+) Total	kWh+	•	•
Imported (+) partial	kWh+	•	-
Exported (-) Total	kWh-	•	•
Exported (-) partial	kWh-	•	-
Imported (+) Total by tariff (t1, t2)	kWh+	•	-
Quadrant I, II, III, IV	kWh	•	-

Reactive energy	Unit	System	Phase
Imported (+) Total	kvarh+	•	•
Imported (+) partial	kvarh+	•	-
Exported (-) Total	kvarh-	•	•
Exported (-) partial	kvarh-	•	-
Quadrant I, II, III, IV	kvarh	•	-

Apparent energy	Unit	System	Phase
Total	kVAh	•	-
Partial	kVAh	•	-
Quadrant I, II, III, IV	kVAh	•	-

Run hour meter	Unit	System	Phase
Total (kWh+)	hh:mm	•	-
Partial (kWh+)	hh:mm	•	-
Total (kWh-)	hh:mm -	•	-
Partial (kWh-)	hh:mm -	•	-
Total ON time	hh:mm	•	-

Electrical variable	Unit	System	Phase
Voltage L-N	V	•	•
Voltage L-L	V	•	•
Current	A	•	•
DMD	A	-	•
DMD MAX	A	-	•
Neutral current	A	•	-
Active power	W	•	•
DMD	W	•	-
DMD MAX	W	•	-

Electrical variable	Unit	System	Phase
Apparent power	VA	•	•
DMD	VA	•	-
DMD MAX	VA	•	-
Reactive power	Var	•	•
Power factor	PF	•	•
Frequency	Hz	•	-
THD Current*	THD A %	-	•
THD Voltage L-N*	THD L-N %	-	•
THD Voltage L-L*	THD L-L %	-	•

* Up to 31st harmonic

Note: the available variables depend on the type of system set.

Measurement accuracy

Current	
From I_{\min} to I_{tr}	+/- 1.0% rdg
From I_{tr} to I_{\max}	+/- 0.5% rdg

Phase-phase and Phase-neutral voltage	
U_n minimum -20% to U_n maximum +15%	+/- 0.5% rdg

Active and apparent power	
From I_{\min} to I_{tr} (PF=1)	+/- 1.5 % rdg
From I_{tr} to I_{\max} (PF= 1 - 0.5 L - 0.8 C)	+/- 1.0 % rdg
Active energy	Class 1 EN IEC 62053-21

Reactive power	
From 0.05 I_n to 0.1 I_n $\text{Sin}(\varnothing) = 1$	2.5%
From 0.1 I_n to I_{max} $\text{Sin}(\varnothing) = 1$	2.0%
From 0.1 I_n to 0.2 I_n $\text{Sin}(\varnothing) = 0.5 L - 0.5 C$	2.5%
From 0.2 I_n to I_{max} $\text{Sin}(\varnothing) = 0.5 L - 0.5 C$	2.0%
From 0.2 I_n to I_{max} $\text{Sin}(\varnothing) = 0.25 L - 0.25 C$	2.5%
Reactive energy	Class 2 EN IEC 62053-23

Frequency	
From 45 to 65 Hz	+/- 0.1% rdg

Measurement resolution







Variable	Display resolution	Resolution by serial communication
Energy	0.001 kWh/kvarh/kVAh	0.0001 kWh/kvarh/kVAh
Single phase energy	0.001 kWh	0.001 kWh
Power	0.001 kW/kvar/VVA	0.1 W/var/VA
Current		0.001 A
Voltage		0.1 V
Frequency		0.001 Hz
THD		0.01 %
Power factor	0.01	0.001

 Display

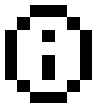
Type	Matrix LCD 128 x 96 pixels
Refresh time	500 ms
Description	Backlit LCD
Variable readout	Instantaneous: 5+1 dgt or 5+3 dgt Power factor: 1+2 dgt Energy: 8+3 dgt

Display icons description

The table reports the icons that can appear on the display.

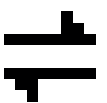









Icon	Description
	Off: Ethernet link inactive (cable disconnected or no link) ON: Ethernet link active (cable connected and link detected) Note: The icon shows only the physical link status. Correct network settings required for communication.
	Wiring information: virtual correction via UCS
	Current range exceeded: the measured value is still displayed
	Voltage range exceeded: the measured value is still displayed
	Undervoltage: the measured value is displayed anyway
	Frequency in an out-of-range condition
	Fixed: internal failure Blinking: alarm signal
	Wiring error
	Reading or writing command is addressed to EM640

LED

Front	Red. Pulse weight proportional to positive energy (display page 1) or negative energy (display page 2)
LED Constant	1000 pulse/kWh

Symbols

The table describes all the symbols that you can find in the documents and on the product.

Symbol	Description
	Dangerous voltage
	Danger, live parts
	Caution
	Provides essential information on completing the task that should not be neglected
	Manual symbol
	Safety sign notice
	The product is not to be discarded with normal household waste
	Double insulation
	Single phase
	Three phase (four-wire)
	Three phase (three-wire)

Communication ports

▶ Ethernet port

Protocol	Modbus TCP/IP HTTPS REST API DHCP mDNS
Devices on the same bus	Maximum 5 connections simultaneously
Connection type	RJ45 connector (10 Base-T, 100 Base-TX), maximum distance 100 m, Integrated switch function to connect another ethernet device
Configuration parameters	DHCP client mDNS Modbus TCP enabling HTTPS REST API
Cable type	Minimum Cat 5, Standard EIA/TIA T568B Ethernet Patch Cable or Ethernet Crossover Cable (autodetection)
Refresh time	Modbus TCP/IP: ≤ 100 ms HTTPS Rest API: ≤ 200 ms HTTPS Webserver: ≤ 3 s
Configuration mode	Via keypad, UCS software/APP

Connection Diagrams

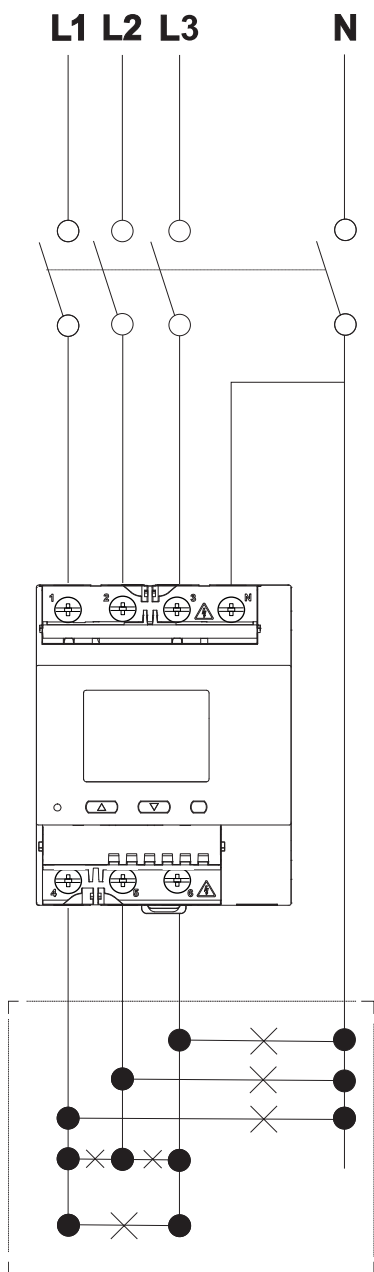

Fig. 3 Three-phase with neutral (4-wire)

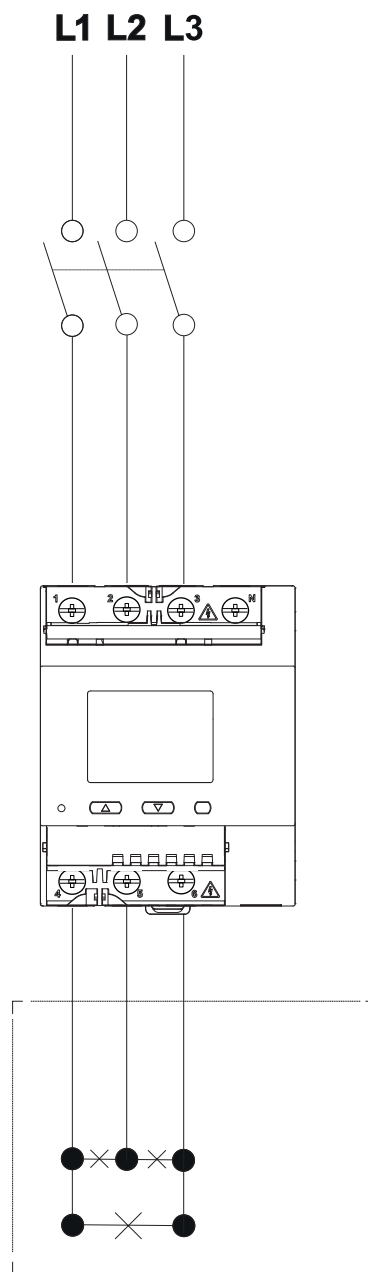

Fig. 4 Three-phase without neutral (3-wire)

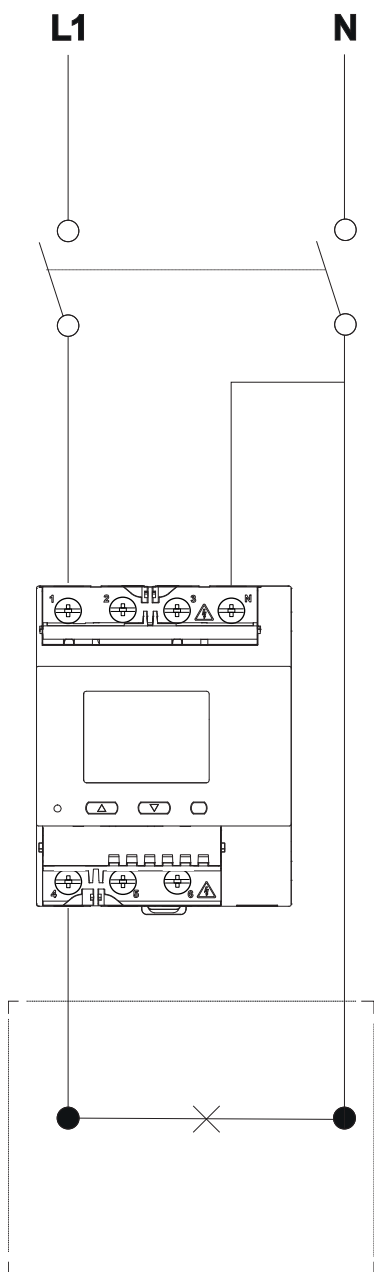

Fig. 5 Single-phase system

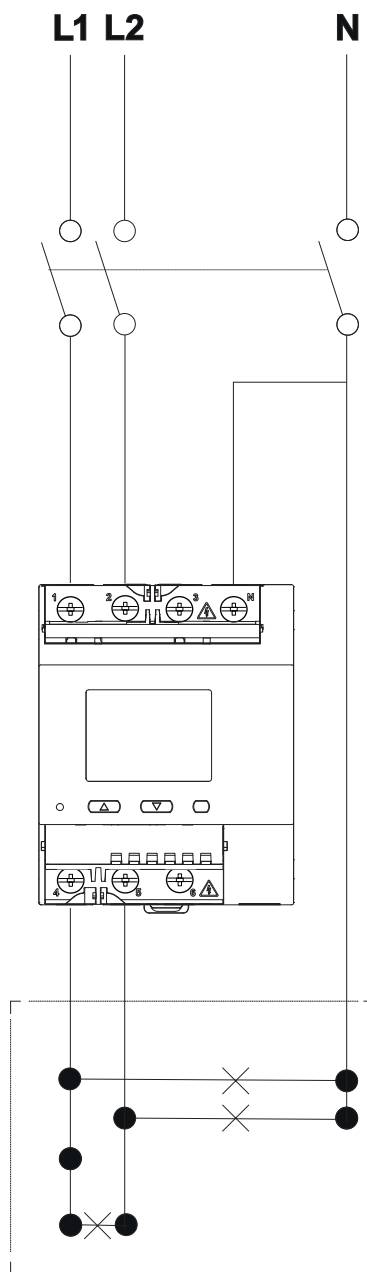

Fig. 6 Two-phase (3-wire)

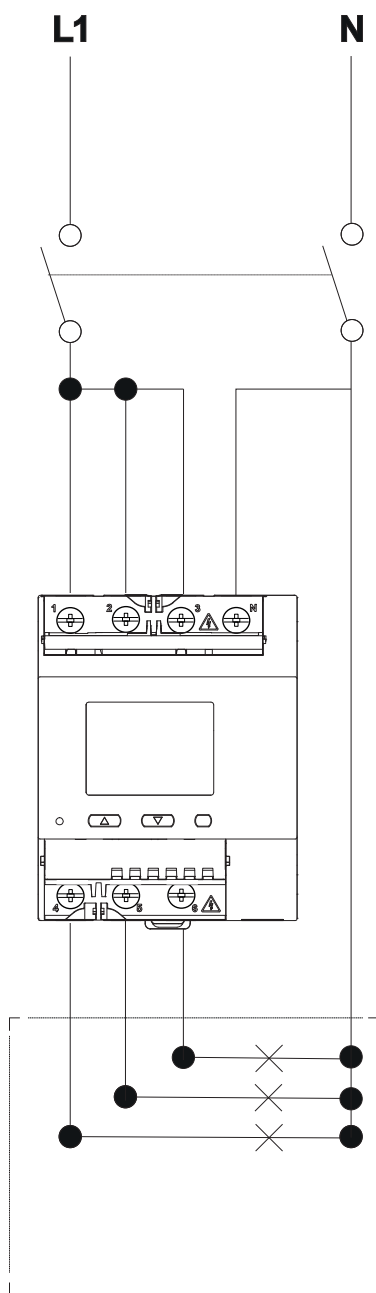

Fig. 7 Single-phase system, 3 loads

References

Order code



EM640 B AV2 3X E2 XX X

Enter the code option instead of

Code	Options	Description
EM640 B	-	-
AV2	-	65 A direct connection
3X	-	Three phase, self power supply
E2	-	Ethernet Modbus TCP
XX	-	-
X	-	cULus

CARLO GAVAZZI compatible components

Purpose	Component name/code key	Notes
Configure analyzer via desktop application	UCS software	Available for free download at www.gavazziautomation.com
Aggregate, store and transmit data to other systems	UWP	For further information please refer to www.gavazziautomation.com



COPYRIGHT ©2026

Content subject to change. Download the PDF: www.gavazziautomation.com